



FEATURES

- For surface mounted applications
- Fast reverse recovery time
- Ideal for automated placement

MECHANICAL DATA

- Case: SOD-123W
- Terminals: Solderable per MIL-STD-750, Method 2026
- Approx. Weight: 16mg/0. 00056oz

PINNING

PIN	DESCRIPTION
1	Cathode
2	Anode

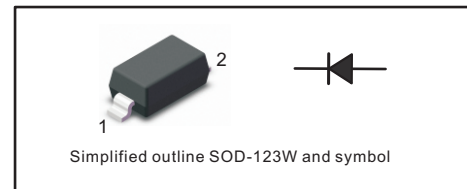

Absolute Maximum Ratings at 25 °C

Parameter	Symbols	1N4448W	Units
Non-Repetitive Peak Reverse Voltage	V_{RM}	100	V
Peak Repetitive Reverse Voltage	V_{RRM}	75	V
Working Peak Reverse Voltage	V_{RWM}		
DC Reverse Voltage	V_R		
RMS Reverse Voltage	$V_{R(RMS)}$	53	V
Forward Continuous Current	I_{FM}	500	mA
Average Rectified Output Current	I_O	250	mA
Non-Repetitive Peak Forward Surge Current @t=1.0 μs @t=1.0 s	I_{FSM}	4.0 2.0	A
Power Dissipation	P_d	350	mW
Thermal Resistance Junction to Ambient Air	R_{thJA}	357	°C/W
Operating and Storage Temperature Range	T_j, T_{stg}	-65 ~ +150	°C

Characteristics at $T_a = 25\text{ °C}$

Parameter	Symbols	1N4448W	Units
Reverse Breakdown Voltage at $I_R=1.0\mu A$	$V_{(BR)R}$	75(min)	V
Forward Voltage at 5 mA at 10 mA at 100 mA at 150 mA	V_F	0.62(min) 0.72(max) 0.855(max) 1.00(max) 1.25(max)	V
Peak Reverse Current at $V_R=75V$ at $V_R=20V$	I_R	2.5(max) 25(max)	μA nA
Typical Junction Capacitance f=1MHz, $V_R=0V$	C_j	4(max)	pF
Maximum Reverse Recovery Time ⁽¹⁾	t_{rr}	4	ns

(1) Measured with $I_F=I_R=10mA, I_{rr}=0.1 \times I_R, R_L=100\Omega$



Fig.1 Power Derating Curve

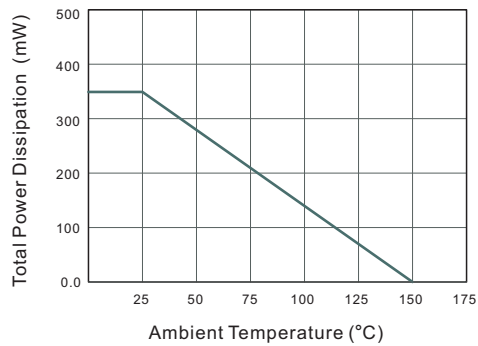

Fig.2 Typical Reverse Characteristics

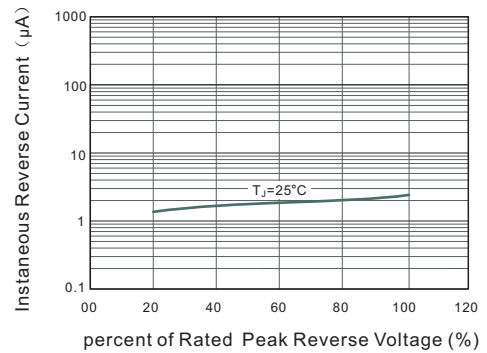

Fig.3 Typical Instaneous Forward Characteristics

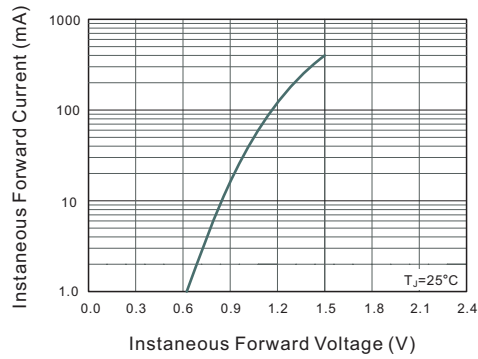
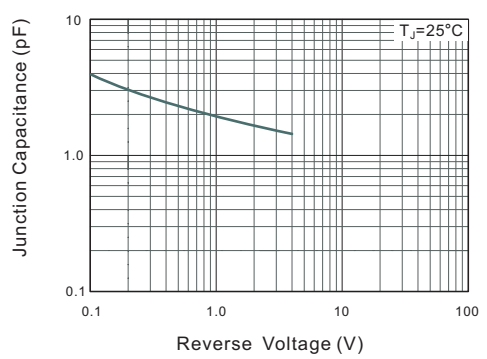

Fig.4 Typical Junction Capacitance





PACKAGE OUTLINE

Plastic surface mounted package; 2 leads

SOD-123W

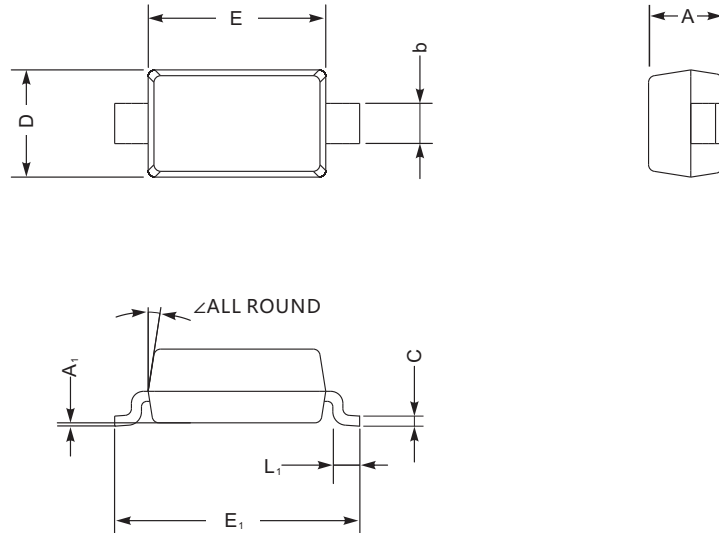

SOD-123W mechanical data

UNIT		A	C	D	E	E ₁	L ₁	b	A ₁	∠
mm	max	1.3	0.22	1.8	2.8	3.9	0.45	0.7	0.2	9°
	min	0.9	0.09	1.5	2.5	3.6	0.25	0.5	—	
mil	max	51	8.7	71	110	154	18	28	8	
	min	35	3.5	59	98	142	10	20	—	

The recommended mounting pad size

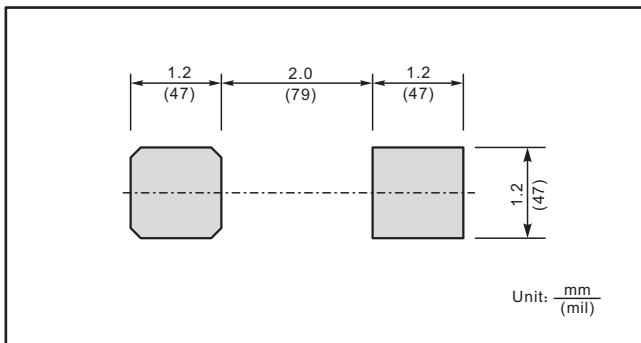

Marking

Type number	Marking code
1N4448W	T5